

# Parking Supplementary Planning Document

July 2018



Basingstoke  
and Deane

# Foreword

This Parking Standards Supplementary Planning Document (SPD) has been prepared by Basingstoke and Deane Borough Council in its role as Local Planning Authority to support the delivery of the Basingstoke and Deane Local Plan 2011-2029. It has been informed by extensive consultation including a six week formal consultation with residents and other stakeholders.

It has been prepared in accordance with The Town and Country Planning (Local Planning) (England) Regulations 2012 and is a material consideration in the determination of planning applications.

# Executive Summary

## What are the aims of this document?

The aim of this Supplementary Planning Document (SPD) is to ensure that in all new developments, a suitable level of well-designed vehicle and cycle parking is provided in order to avoid the problems and issues associated with the provision of inadequate or poorly designed parking for vehicles and cycles which have been experienced in the past.

It also seeks to support the aims of both local and national policy. At a national level, this includes developing evidence based parking standards and the emphasis being on good design. At a local level this document provides further detail to supplement the policies of the adopted Local Plan, particularly Policy CN9 (Transport) and Policy EM10 (Delivery High Quality Development).

This SPD encourages the provision of good quality development by setting out clear requirements and guidance with regards to parking when designing new developments.

## Who is this document for?

This SPD will be used by developers and their consultants when they are designing new developments. It will also be used by Basingstoke and Deane Borough Council councillors and officers to assess new developments where planning consent is being sought. Residents and other interested parties are also encouraged to refer to this document as it sets out the councils expectations regarding parking provision in new developments.

## Where does it apply?

The parking standards set out in the document apply to the area within the Basingstoke and Deane Borough Council boundary.

## What does it include?

- Parking Standards for residential and non-residential developments reflecting car ownership levels.
- Inclusion of design and layout guidance setting out minimum dimensions for parkings space sizes and garages to ensure that parking provided at sites is useable for typical vehicles. It also sets out expectations regarding the design and layout of parking and provides good practice guidance and examples along with design and layout principles.
- Cycle parking and electric vehicle charging and parking standards and design and layout guidance.

# Contents

Introduction	4
Planning Policy Context	5
General Principles	7
<b>Part A: Residential Parking Standards</b>	
Background Evidence	8
Table of residential parking standards	11
Parking design and layout:	14
<i>Parking space dimensions</i>	14
<i>On-street parking</i>	15
<i>Off-street parking</i>	16
<i>Electric vehicle charging and disabled parking</i>	19
<i>Cycle parking</i>	21
<b>Part B: Non-Residential Parking Standards</b>	
Background Evidence	24
Table of non-residential parking standards	25
Parking design and layout:	32
<i>Parking space requirements</i>	32
<i>Operational parking, servicing and loading</i>	33
<i>Electric vehicle charging</i>	34
<i>Motorcycle, moped and scooter parking</i>	35
<i>Cycle parking</i>	36
References	39

# Introduction, Planning Policy Context and General Principles

## 1. Introduction

- 1.1 This SPD sets out the Council's approach to car and cycle parking in new developments in the borough. It provides further detail to the adopted policies of the Basingstoke and Deane Borough Local Plan 2011-2029, specifically policies CN9 and EM10. It replaces both the Basingstoke and Deane Residential Parking Standards SPD (2008, updated in 2012) and the Hampshire Parking Strategy and Standards (2002). Applications for planning permission will be assessed against the guidance contained within this document.
- 1.2 A balanced approach to delivering parking can help stimulate growth and meet the needs of our residents. It is not intended to suppress the use of the car, or to promote the car over other forms of transport such as walking, cycling and public transport. This document aims to deliver effective parking solutions while taking account of other planning considerations.
- 1.3 The principal objectives associated with developing a revised set of parking standards for the borough are as follows:
  - To provide high quality, well-designed places to live, work and visit with safe, convenient and useable parking provision
  - To ensure a consistent and transparent approach to assessing planning applications
  - To respond to the particular characteristics of different neighbourhoods and localities in the borough in terms of accessibility by all modes of transport and restrictions on space availability
- 1.4 This document incorporates the findings of recent research and analysis to develop parking standards which are more responsive to local circumstances. The SPD is split into two sections covering residential and non-residential parking. It contains guidance on the levels of car, cycle, motorcycle, electric car charging and disabled parking that should be provided. The inclusion of layout and design expectations also demonstrates how car parking should be integrated into a high-quality external space. It should be read in conjunction with the council's Design and Sustainability SPD.
- 1.5 It is expected that applicants will refer to the council's expectations in relation to both the quantum of parking required set out in the parking standards tables and the parking design and layout principles to guide parking design.
- 1.6 The parking standards and design guidance set out in this SPD are based on current evidence. Ongoing work being undertaken on the Transport Strategy in response to the borough's longer term growth aspirations is likely to recommend a widening of travel choices which over time will require a step change in public transport provision. Future reviews of these parking standards will respond to the expected improvements in accessibility likely to result from implementing the transport strategy's recommendations.

## 2. Policy Context

### National Policy

- 2.1 National planning policy has, as one of its core principles, a requirement to actively manage patterns of growth to make fullest possible use of public transport, walking and cycling, and focus significant development in locations which can be made more sustainable.
- 2.2 Transport policies have an important role to play in facilitating sustainable development but also in contributing to wider sustainability and health objectives. National policy refers to a transport system being balanced in favour of sustainable transport modes, giving people a real choice about how they travel. It also requires all developments that generate significant amounts of movement to be supported by a Transport Statement or Transport Assessment to determine the likely impact of the proposed development.
- 2.3 Alongside this, the NPPF (2012) makes provision for local authorities to set parking standards for residential and non-residential development to reflect their local circumstances. When setting local parking standards council's must take account of the following:
  - The accessibility of the development;
  - The type, mix and use of development;
  - The availability of and opportunities for public transport;
  - Local car ownership levels; and
  - An overall need to reduce the use of high-emission vehicles.
- 2.4 The government acknowledges that local planning authorities are best placed to set standards based on local circumstances and the needs and aspirations of their communities but clarifies that they should only impose local parking standards for residential and non-residential development where there is a clear and compelling justification that it is necessary to manage their local road network.
- 2.5 The Planning Practice Guidance (PPG) provides further detailed guidance on the policies set out in the NPPF requiring local planning authorities to seek to ensure parking provision is appropriate to the needs of the development and not reduced below a level that could be considered reasonable.
- 2.6 It states that maximum parking standards can lead to poor quality development and congested streets and promotes greater freedom for local planning authorities to set parking standards appropriate to their areas.
- 2.7 The PPG reinforces the importance of travel plans and transport assessments stating that travel plans should be considered in parallel to development proposals and readily integrated into the design and occupation of the new site to identify and implement alternatives to the private car. Transport Assessments are supported as a means of taking forward the identified mitigation measures which relate to on-going occupation and operation of the development.
- 2.8 Complementing the NPPF and PPG is Manual for Streets (MfS), published in 2007. MfS highlights that parking is one of five key functions of most streets and that well-designed parking can add to the vitality of the street. Manual for Streets 2 (MfS2),

published in 2010, builds on MfS and explains how its principals can be applied more widely. More locally a companion guide to MfS has been prepared by Hampshire County Council. Guidance provided in MfS, MfS2 and the companion guide has been used to help inform the layout and design standards detailed in this SPD.

## Local Policy

2.9 The development plan for the Borough is the Basingstoke and Deane Local Plan 2011-2029 (along with any 'made' Neighbourhood Plans). The Local Plan's objectives include reducing the need to travel, providing sustainable and fully accessible transport opportunities, promoting walking and cycling and protecting and proactively managing the borough's built environment to ensure quality and distinctiveness. This document provides further detail to supplement the policies of the adopted Local Plan, particularly Policy CN9 (Transport) and Policy EM10 (Delivery High Quality Development).

2.10 **Policy CN9 'Transport'** states that the Council will work in partnership to promote a safe, efficient and convenient transport system. The policy text is set out below, of particular relevance is criterion (h):

*Development proposals will be permitted that:*

- a) *Integrate into existing movement networks*
- b) *Provide safe, suitable and convenient access for all potential users*
- c) *Provide an on-site movement layout compatible for all potential users with appropriate parking and servicing provision*
- d) *Do not result in inappropriate traffic generation or compromise highway safety*

*Development should be of high quality, sustainable in design, construction and layout, offering maximum flexibility in the choice of travel modes, including walking and cycling, and with accessibility for all potential users. Development will be permitted where:*

- e) *Does not have a severe impact on the operation, safety or accessibility to the local or strategic highway networks*
- f) *Mitigates impacts on the local or strategic highway networks, arising from the development itself or the cumulative effects of development, through the provision of, or contributions towards, necessary and relevant transport improvements, including those secured by legal agreements or through the Community Infrastructure Levy*
- g) *Protects and where possible enhances access to public rights of way*
- h) *Provides appropriate parking provision, in terms of amount, design and layout, in accordance with the adopted Parking Standards*
- i) *Provides appropriate waste and recycling storage areas and accessible collection points for refuse vehicles, in accordance with the Design and Sustainability SPD ; and*
- j) *Ensures that all development proposals provide a co-ordinated and comprehensible scheme that does not prejudice the future development or design of suitable adjoining sites.*

2.11 **Policy EM10 'Delivering High Quality Development'** requires development proposals to be high quality and based on robust design-led approach. In relation to parking, criterion (e) requires that:



*“appropriate parking provision (including bicycle storage) in terms of amount, design, layout and location, in accordance with adopted parking standards are provided.”*

- 2.12 There are also a number of Neighbourhood Plans which now form part of the development plan for the borough and are relevant in the determination of planning applications, within the relevant neighbourhood areas. Many of these Neighbourhood Plans refer to parking issues or have policies relevant to expected levels of parking. The full list of ‘made’ neighbourhood plans is regularly updated and available on the Council’s website [here](#)<sup>1</sup>. These plans should also be referred to in conjunction with this document where relevant.

### 3. General Principles

- 3.1 As required by Basingstoke and Deane Local Plan policy CN9, development proposals should provide safe, suitable and convenient access for all potential users, with appropriate parking and servicing provision without comprising highway safety.
- 3.2 Applicants are expected to provide a parking statement setting out the approach taken to parking provision. The statement should demonstrate how a high quality design has been achieved and how the development will be used in relation to the parking provided having regard to policies CN9 and EM10. This information can be contained within the Design and Access Statement (if required).
- 3.3 This SPD seeks to ensure that parking provision is well designed and available in the right location. This SPD should be read in conjunction with the Council’s Design and Sustainability SPD which provides further detail in relation to the design matters associated with parking provision. A number of principles aimed at achieving high quality design and layout of parking are set out below:
- Functional parking needs of developments are accommodated on or close to the site without prejudicing highway safety or other planning objectives
  - The location of parking should always respond positively to the character and appearance of the street scene and the surrounding area.
  - There is no single solution to providing car parking and a combination of on-plot and off-plot parking is likely to be appropriate especially on larger schemes.
  - Car parking should always be located close to the property it serves as convenience and location of parking spaces effect behaviour as the more convenient parking is the more likely it is to be used.
  - Consideration needs to be given to parking for visitors and disabled parking
  - Design solutions should avoid large expanses of hard surfacing, and ensure that parked vehicles do not dominate street frontages.
  - A mixture of high quality materials and landscaping should be used to break up and improve the appearance of parking areas. The landscaping scheme should be resilient to pedestrians and vehicles and should be appropriate to the level of management that the parking area will receive.
  - Car parking needs to be designed with security and accessibility in mind.
  - Parking areas should be designed to minimise surface water run-off through the use of sustainable drainage systems such as permeable paving.

---

<sup>1</sup> Neighbourhood Plans Progress website address:  
<https://www.basingstoke.gov.uk/neighbourhoodplansprogress>



# PART A: RESIDENTIAL PARKING

## Residential Parking Standards

### 4. Background Evidence

- 4.1 In accordance with national policy, it is important to ensure that the borough's parking standards reflect local circumstances, and strike the right balance between providing a sufficient number of car parking spaces (to prevent vehicles from being displaced onto the public highway), promoting good design and using land efficiently. The following section provides a summary of the background evidence supporting the parking standards for residential development.

#### Car Ownership Trends

- 4.2 The provision of adequate parking in line with the expected future car ownership levels remains the priority of this SPD. If parking provision is not made to meet the likely level of car ownership in new developments then inappropriate parking causing inconvenience, road safety issues and unattractive environments is likely to occur.
- 4.3 The 2011 census continues to show a high level of car ownership in the borough compared to the national average. Nationally 32% of households have two or more cars, in the south-east 40% of households have two or more cars, whilst in the borough almost 45% of households have two or more cars. Car ownership in the borough has risen from a total of 91,722 cars in 2001 to 100,592 in 2011, an increase of 9% between 2001 and 2011. On average across the borough as a whole car ownership levels average at 1.45 cars per household.
- 4.4 However, the evidence indicates that car ownership does vary significantly across the borough, and is influenced by factors such as location, accessibility, tenure and number of habitable rooms. The highest number of households without a car are in wards in Basingstoke (in Eastrop 32% of the properties in the ward do not have a car, Norden 29% and South Ham 29%), the lowest number of households without a car are in more rural locations, the lowest being East Woodhay where 5% of households do not have a car. Figure 1 overleaf illustrates the borough's 2011 car ownership levels compared to the rest of the south east and England and shows that the average cars per household changes across different geographies and can be affected by accessibility and proximity of public transport.

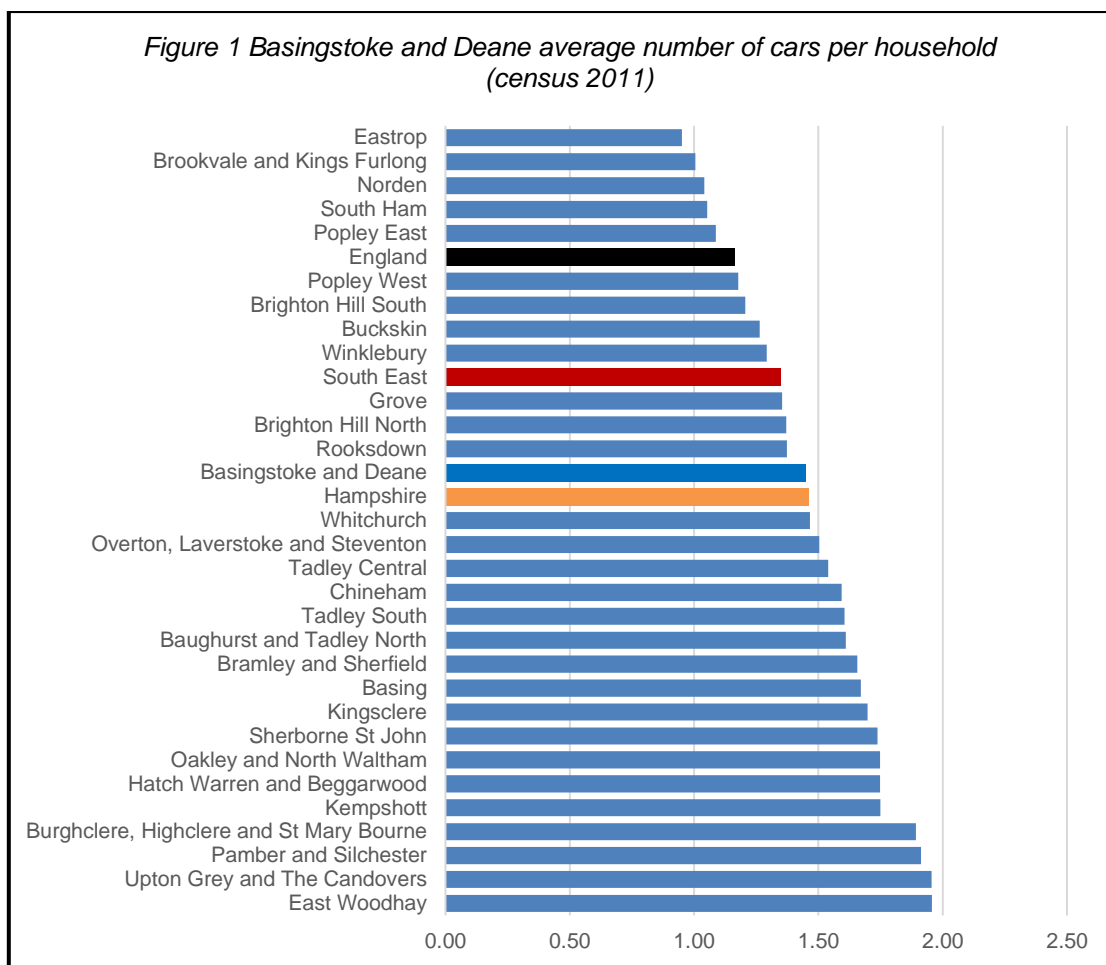

4.5 The evidence suggests that even if more sustainable modes of transport and a greater choice of travel is available such as in the wards in Basingstoke town centre residents are likely to still retain the option of keeping at least one car. It is therefore important that proper provision is made to reflect this demand.

4.6 With regards to the relationship between the number of bedrooms in a property and the number of cars in the household, the census data indicates that the smallest properties are generally associated with having no cars and the larger with owning four or more cars, it therefore remains appropriate to apply parking standards in relation to the number of bedrooms in the property. Levels of car ownership are lower for residents living in flats in comparison to houses and almost half of households living in one bedroom flats in the borough do not have any cars or vans in the household (47.3%).

*Figure 2: Basingstoke and Deane car ownership by dwelling size (2011 census)*

Dwelling size	Average car ownership	Average car ownership in households with access to a car
1 bedroom	0.67	1.19
2 bedrooms	1.05	1.37
3 bedrooms	1.44	1.64
4 bedrooms	1.95	2.02
5 or more bedrooms	2.32	2.38

- 4.7 Whilst the increasing provision and attractiveness of alternatives to the car are a factor there is no evidence to suggest that the general levels of car ownership will reduce overtime. Across the borough as a whole, the number of cars increased by 9% between 2001 and 2011. General forecasts taking account of expected growth to 2029 show an increase in car ownership in the borough taking account of growth in population and households. These projected car ownership levels are reflected in the table of residential parking standards below.

*Figure 3: Forecast change in car ownership*

<b>Basingstoke and Deane Borough</b>		
<b>Number of bedrooms</b>	<b>Average car ownership 2011</b>	<b>Projected average car ownership 2029</b>
Total	1.44	1.51
1 bedroom	0.67	0.71
2 bedrooms	1.05	1.10
3 bedrooms	1.44	1.52
4 bedrooms	1.95	2.05
5 or more bedrooms	2.32	2.44

### **Research and experience of recently built residential development in Basingstoke**

- 4.8 A number of developments permitted and built in the last ten years were surveyed, the main observations of inappropriate parking included parking on or partly on the footway, parking on bends or junctions, parking on verges or landscaped areas and high volumes of obstructive parking on the highway. Residents reported mis-use of visitor parking, garages not being used to park cars and inconvenient location of car parking meaning that it is not used and inconsiderate parking.
- 4.9 From the observations made it is apparent that the level and problems associated with “on street parking” to some extent relate to the way that parking in these developments is provided, in terms of the type of space, the parking layout and parking design. Unless housing layouts are well designed, there is a tendency for indiscriminate on-street parking to the front of the property for either convenience or security reasons. A further observation was that where the parking requirement is reliant upon garages to meet the parking standard there is more evidence of indiscriminate parking probably due to garages not being used for parking.

### **Conclusions drawn from background evidence**

- 4.10 The parking standards reflect projected car ownership levels and enable developers to provide more parking at sites in less accessible areas, to reflect current and projected car ownership levels but continues to promote a lower level of parking in more accessible areas to encourage more efficient use of land and more sustainable travel patterns. A reduction in car parking provision below the rates set out in table 1 in highly accessible locations through innovative design or the provision of other incentives such as car or bike clubs should be promoted by applicants wherever possible.

- 4.11 After surveying recently built residential development and seeking residents' views it is apparent that even when the required number of parking spaces for new development are provided, there remains parking problems in some locations as in some cases the interpretation of the standards and local parking design issues have led to parking problems arising. There therefore needs to be a clearer focus on the design and layout of parking spaces placing a greater emphasis on location and design of parking spaces and in the way they are provided. This SPD therefore sets out detailed design and layout guidance for residential development in sections 6-10.

## **5. Table of Residential Parking Standards**

- 5.1 The Council's residential parking standards seek to strike a balance between providing sufficient on-site parking to meet residents' needs, environmental sustainability and good design. Consideration will only be given to a reduced parking standard where full justification is provided. Planning applications must include information to demonstrate to the satisfaction of the council that the functional parking needs of the development can be accommodated.
- 5.2 The residential parking standards are tabulated overleaf. These standards apply to new development and parking provision, they do not seek to be retrospective. In applying the standards overleaf applicants must also take into account the notes set out below the table.
- 5.3 The table overleaf should be read in conjunction with the design and layout guidance set out later in this document. This section reflects the council's emphasis on the importance of well-designed, responsive parking that is not considered in isolation to the principles of good design. Manual for Streets, Manual for Streets 2 and the 'Secured by Design' initiative and best practice have all been referenced in developing the detailed advice and guidance in this section.

## Table 1: Residential Parking Standards

Property Size	Car Parking Standard				Cycle Parking Standard		
	Inner urban <sup>2</sup>	Outer urban and rural settlements <sup>3</sup>		Rural <sup>4</sup>	Long term secure storage	Short term communal storage <sup>5</sup>	
	With 50% or more unallocated spaces	Between 20% and 50% unallocated spaces	With 50% or more unallocated spaces	Between 20% and 50% unallocated spaces	Between 20% and 50% unallocated spaces	With 50% or more unallocated spaces	
1 bedroom units	1.0	1.0	1.0	1.25	1.0	1.0	
2-3 bedroom units	1.25	1.5	1.5	1.75	2.0	1.0	
4 + bedroom units	2.0	2.25	2.5	2.75	3.0	1.0	
Retirement/sheltered /extra care housing	To be determined on a case by case basis demonstrated by a transport assessment, transport statement or travel plan as appropriate. Survey data of comparable sites and explanation of anticipated car levels relating to the particular care model being proposed will be required. Ambulance and mini-bus parking provision should also be considered.						
Residential care homes and nursing homes							

<sup>2</sup> Within Basingstoke ring-road

<sup>3</sup> Within the Settlement Policy Boundaries (as defined on the adopted 2011-2029 Local Plan proposals map) of the following: Basingstoke (including Chineham), Old Basing, Whitchurch, Overton, Tadley, Bramley and Oakley.

<sup>4</sup> The remainder of the borough

<sup>5</sup> Where appropriate

**In applying the above standards, the following considerations must be taken into account:**

1. Figures provided in the table should be viewed as the expected standard, however as noted above each development will be considered on an individual basis taking into account local circumstances and evidence. Parking provision to a lower standard may be appropriate on the most sustainable sites in accessible locations if circumstances permit and incentives, such as car clubs, are provided as part of a development. Developers will be expected to provide evidence to demonstrate the approach taken.
2. All proportions to be rounded up to the next whole number.
3. All parking provision should be in line with recommendations in the Design and Sustainability SPD.
4. A statement justifying the approach taken is required for all developments
5. Parking space minimum dimensions are set out in section 6
6. Unallocated spaces encompass both communal and visitor parking.
7. Unallocated parking should only be utilised in developments of 20 units or more, in order for variances in ownership, etc. to work.
8. Only garages that comply with the minimum internal areas set out in the design and layout section of this SPD will count as a parking space.
9. A minimum of 5% of unallocated spaces should be available for conversion to future use by disabled people.
10. As a minimum all new developments should ensure that the electricity infrastructure for individual dwellings is sufficient to enable supply to be provided for electric vehicle charging. Developers are also encouraged to provide electric vehicle charging at the time of build in at least some of the visitor parking bays. If these facilities are not provided at the time of build then the design of parking arrangements and electrical connections should be configured in such a way that EV charging points can be retro fitted to parking bays without unreasonable levels of disruption.
11. Shared driveway developments must make provision for access and loading for delivery vehicles.
12. Driveways longer than 5.5m will be counted as a single parking space unless the developer can adequately demonstrate that the driveway can reasonably accommodate more than one vehicle.
13. All parking should be part of a Sustainable Urban Drainage System (SuDS) unless there are technical reasons why this cannot be done. Permeable surface materials should be used wherever possible to reduce surface water runoff.

# Parking Design and Layout in Residential Developments

## 6. Residential parking space dimensions

- 6.1 Car parking spaces should be of an adequate size to allow convenient parking and ingress and egress from the vehicle. The size of spaces required has grown over recent years as average car sizes are increasing, as popular models increase in size and 4x4s, sport utility vehicles (SUVs) and multi-purpose vehicles (MPVs) take a greater market share.
- 6.2 The required parking space size for cars is 2.7m wide by 5.2m in length. Where smaller spaces are proposed, robust supporting information must be submitted to justify the approach taken. Space sizes smaller than 2.5m wide by 5.0m in length will not be accepted. Table A below sets out the requirements associated with different parking space configurations.

*Table A Residential parking space dimensions*

Type of car parking space	Parking space requirements
Parking space size 2.7m wide by 5.2m in length	
Parking within the curtilage of a property	Car parking spaces confined by walls, fences or landscaping should be 3m wide. Where the driveway or hardstanding also serves as the primary pedestrian access path to the property 0.9m of clear space will be required. No part of the vehicle must overhang the footway/ carriageway.
Parallel Parking Bays	Minimum dimensions 2.5m x 6.0m. Should be designed so that bays cannot be used for echelon parking.
Perpendicular Bays (90° to approach)	6m required between aisles for manoeuvring
Echelon Bays (60° to approach)	Bays should be arranged to encourage reverse parking 4.2m required between aisles for manoeuvring
Echelon Bays (between 45° and 30° to approach)	Bays should be arranged to encourage reverse parking 3.6m required between aisles for manoeuvring
Single Garage (recommended dimensions)	3.3m x 7.0m internal dimensions to be counted as parking space Minimum door width 2.3m Minimum height 2.3m
Car Port/ Car Barn	Minimum dimensions of 2.9 x 5.5m. If there is to be parking in front of the structure at least 5.5m must be left to avoid overhang onto the footway/ carriageway.
Disabled Spaces	Should be located as close to the main entrance as possible. An additional 1m along either side of the parking bay and at the rear of the space is required for access.



Lifetime Homes	Parking spaces for accessible units need to be Building Regulations Part M compliant. Parking spaces within dwelling curtilage need sufficient space to be widened to 3.3m. Parking bays within communal parking areas minimum clear access zone of 900m to one side.
Electric Vehicle Spaces	Additional 1m access stip.

## 7. On-street parking

### On street parking principles

- 7.1 On-street residential parking will only be considered if formally laid out bays are provided, with adequate carriageway widths to enable unobstructed two-way vehicle movements (including cycles), or unobstructed one-way vehicle movements (including contra-flow cycling) in one-way streets. The spaces should relate well to the dwellings which they are to serve to avoid confusion and unauthorised use, they should normally be positioned no more than 20m away, in order to encourage maximum usage and have appropriate signing or numbering with a clear link to the principle building entrance.
- 7.2 In addition to the formal unallocated parking spaces outlined below, there will always be casual callers and service vehicle drivers who find it convenient to park on the carriageway and requirements for this demand must be planned for in the design. A recommended carriageway width of 5m should be provided to allow one service vehicle to pass parked vehicles.
- 7.3 If less than 5m carriageway width is available, separate parking lay-bys or other forms of parking provision will be required. Unallocated on-street parking spaces may be considered for adoption by the Highway Authority provided they are constructed to the appropriate standard.
- 7.4 When new residential development is proposed in areas of the borough where a residents parking scheme or other form of controlled parking zone is in operation, new developments should be designed so as not to rely on a limited resource of permit parking and instead make their own provision. Parking controls should also be considered in locations where in-appropriate parking may cause a safety, visibility or congestion issue.

### Intensification of use, extensions and change of use

- 7.5 Conversions from offices or other uses into residential, conversions of dwellings into multiple occupation (HMOs) or sub-divisions of existing dwellings can have the potential to increase the demand for parking in an area. In certain circumstances planning permission is not required to change between different uses, in these cases the council has little control over whether such schemes have adequate parking provision. However, where planning permission is required, the Council's intended starting point is set out in below.
- 7.6 Where the proposal is for the conversion of a dwellings into a HMO, the provision of one parking space per bedroom.

- 7.7 With regards to sub-divisions of houses into flats, the standards will be applied as per the residential parking standards set out in table 1 and a parking survey will be required to demonstrate that parking for new residents can be provided without detriment or impacting on the parking available to existing residents.
- 7.8 For proposals to extend or change the use of a building, the developer must demonstrate that adequate parking will be provided. It is especially important to ensure that there is adequate parking provision should the change of use be from a garage into a habitable room for a residential dwelling.
- 7.9 Any parking surveys undertaken should include the following information:
- Scaled plan indicating private accesses, on-street parking bays, unmarked roadside parking, waiting restrictions and public car parks up to 100m distance from the proposed development.
  - Information relating to the likely levels of car ownership amongst occupants
  - An assessment of parking activity in an identified vicinity of the application site. This needs to be recorded regularly (on a typical day) and between 6am and 11pm one weekday and one weekend day by an independent assessor. The applicant will need to be able to demonstrate that the survey undertaken is fair and representative.
  - The survey results would be required to provide mapped records of the parked vehicles locations at each regular count interval and would need to be at a time unaffected by seasonal variations
  - Information relating to proximity of public transport

## Unallocated parking

- 7.10 Where between 20% and 50% of spaces are unallocated the standards include an additional 0.25 spaces per dwelling for unallocated/communal use. If more than 50% of the parking provision associated with the housing development is unallocated (i.e. communal parking) then less parking is required as the use of unallocated spaces can significantly reduce the overall number of parking spaces to be provided in any scheme. This allows for changes in car ownership between individual dwellings over time and provides for both visitors and resident's needs.
- 7.11 Unallocated parking must be provided in public areas where it can be accessed by all, readily apparent from a visitors view point and easily accessible from the street. It must also be equally distributed through the development. Signing is required to identify the status and location of unallocated communal parking spaces. Where there is likely to be additional impact on unallocated parking (e.g. the site is close to commercial uses) the parking design should include an approach to control mis-use.

## 8. Off-street residential parking

### On plot parking layout

- 8.1 Where access is taken from a classified road, it is recommended that the layout to accommodate on-plot parking will enable all vehicles to enter or leave in a forward gear. Turning diagrams may be required to demonstrate that vehicles can manoeuvre safely into and out of spaces.

- 8.2 Tandem parking (i.e. one car behind another) will be acceptable for individual properties only, and not those with parking which is intended for use of more than one dwelling. Additional spaces will not contribute to the overall standard. A over dominance of tandem parking will be discouraged.

### Domestic garage provision and size

- 8.3 National and local research suggests that a significant number of garages are not used for car parking as they are being used for other purposes such as general storage. This can create additional demand for on-street parking. It is acknowledged that storage space is important, particularly as many properties do not have much storage space within the dwelling itself and therefore that garages are, in many cases, being used for other purposes.
- 8.4 Under the previous standards, garages counted towards a parking space allocation which has in some locations resulted in increased pressure on on-street parking. For this reason in order to count as a parking space single residential garages shall have a minimum internal area of 7m by 3.2m.
- 8.5 New garages of the above dimensions and over are considered large enough for the average modern sized family car and cycles, as well as some storage space and will therefore be considered to count as a parking space.
- 8.6 Additional width will be required to accommodate the frame. The height of the door should be such that a minimum drive-through height clearance of 2.3m is provided when the door is open, taking into account that an up-and-over panel also hangs down in the opening when the door is up and reduces the drive-through height.

### Set Backs

- 8.7 Construction of garages and driveways adjacent to the highway using insufficient set-backs have led to widespread abuse by residents who use this area plus the adjacent/footway/cycleway/verge to park vehicles perpendicular to the main carriageway. This occurs when garages are set back from the road but do not include a full vehicle space in front. This creates an obstruction of the footway and whilst this is an enforcement issue in existing situations, it is appropriate to ensure this does not occur as frequently in the future.
- 8.8 When designing garages and driveways which are directly adjacent to the highway, they must be set back a minimum distance of 5.5m behind the highway boundary.



*Example of inadequate set back space being used for parking causing the vehicle to overhang onto the footway. Using the standard detailed above, the setback for the property in the picture should be a minimum of 5.5m.*

## Car Ports

- 8.9 Manual for Streets recommends that ‘*car ports are unlikely to be used for storage and should therefore count towards parking provision*’ and as such, with planning conditions applied to prevent the enclosure of these structures (doors), their inclusion within parking space allocations will be acceptable providing the layout and dimensions are adequate.



*Example of a car barn: Open car ports and car barns are less likely to be used for non-car parking uses and will count towards the parking requirement. They should be designed so that the uprights of the structure do not prevent opening of car doors.*

## Parking Courts

- 8.10 The evidence indicates that parking courts can be unpopular and residents will often avoid using them if there is opportunity for them to park informally outside their home. However, smaller parking courts that have direct connectivity between the parking space and the building entrance or are linked to the back garden of a property have proven to be more popular and better used as they reflect convenience. Applicants are expected to demonstrate their approach to parking through a parking statement which should consider how residents will use the spaces provided.
- 8.11 Parking courts must be in close proximity to the dwellings they serve and include adequate lighting and manoeuvring space and should serve a small number of dwellings. Sufficient space should be provided to allow vehicles to reverse; 6m between rows of spaces is normal sufficient. Acceptable access for multiple vehicle movements and segregation (and signing) between parking spaces in different ownerships will be required.

# Electric Vehicles, Car Clubs and Disabled Parking in Residential Developments

## 9. Electric vehicle charging and parking

### Electric vehicle charging

- 9.1 National Guidance states that developments should be located and designed where practical to (amongst other things) incorporate facilities for charging plug-in and other ultra-low emission vehicles.
- 9.2 The UK government recently announced plans to end the sale of petrol and diesel cars by 2040, which is part of a long-term plan to tackle air pollution. It is estimated that there will be 600,000 electric vehicles on the roads in the UK by 2020 and 1,600,000 by 2030.
- 9.3 Sustained government and private support and investment, improvements in charging technology, charging speed, increasing number of types and styles of vehicles available, reducing cost of vehicles and increase in 'range' are all contributing to more motorists seeing electric vehicles as an attractive option. Electric vehicles will, as a result, become more common and many of the households who will be living in the residential properties being built now will require charging and parking provision.
- 9.4 In line with the Council's adopted Climate Change Strategy and to keep pace with the estimated growth in this emerging technology and to support improvements in air quality, the Borough Council supports the provision of electric vehicle charging points within residential developments on-plot, on-street and within communal parking areas.
- 9.5 The Council is seeking to work with developers and providers to include charging points for electric vehicles in new developments and can provide advice on funding and technical specifications. Hampshire County Council have also developed an Electric Vehicle Charging Framework which will provide additional detail and technical guidance for the provision of electric vehicle charging infrastructure. Planning applications for residential development are strongly encouraged to include provision for electric vehicle charging points in both unallocated and allocated parking spaces.
- 9.6 As a minimum all new homes should incorporate a suitable electricity circuit to enable the convenient fitting of a charging point on plot at a later date by the occupants as a plug-in vehicle represents the largest electrical appliance in a household (drawing more power than a cooker or power shower). The provision of such infrastructure will ensure that homes are future proofed to meet expected demand as needs and technology change. Details of electric vehicle charge points must accompany full and reserved matters planning applications. Outline applications need only a commitment to provide details at the reserved matters stage.
- 9.7 Where electric vehicle charging points are not provided, parking areas should be designed so that charging infrastructure can be retrofitted at a later date with minimal disruption and sensitively designed to avoid visual impact. Whilst it is a fast evolving market and it is difficult to predict what innovations may occur in the future the following are relevant considerations:
- Ability to retrofit a charger to an exterior wall of the house adjacent to a parking space for that house
  - Possibility of integration with street lighting posts adjacent to bays



- Including grass verges at the end or side of parking bays so that it's easier to install and bury cables
- 9.8 With regards to technical standards, the following will be required:
- Charging points must be protected from collision and should be positioned to avoid becoming an obstruction
  - Electric vehicle charge points and cable enabled points must be shown on the layout plan
  - Minimum of one charge point to be accessible to disabled drivers in a disabled-use parking space
  - Bays should be signed and marked for electric vehicle charging only

### Car club vehicles

- 9.9 Car clubs have a vital role to play in reducing society's dependence on the car by giving member's access to a car for essential journeys without the need to own one. It is estimated that for each car club car in operation, 5.4 private vehicles are taken off the road. Car clubs can contribute towards reducing congestion, parking problems, reducing local pollution levels, promoting neighbourhood co-operation and avoiding social isolation and could also increase the viability of low-car housing and contribute to achievement of travel plan objectives.
- 9.10 Sufficient consideration should be given to car club use and therefore the provision of car club parking bays. Where provided they should be located as conveniently and as prominently as possible to maximise the marketing potential. These should be clearly labelled as car club spaces. It is expected that car club bays shall include electric vehicle charging points.

### Disabled Parking

- 9.11 Parking provision suitable for disabled parking (or conversion to) should be provided as 5% of the unallocated provision. It is preferable to provide these spaces in unallocated areas, including on street, as it is not normally possible to identify which properties will be occupied by, or visited by, disabled people. It is recommended that spaces for disabled people are generally located as close as possible to building entrances. These bays should be designed so that drivers and passengers, either of whom may have a disability, can get in and out of the car easily and safely.
- 9.12 Extra space is required for disabled parking to ensure easy access from the side and rear for those with wheelchairs, and protects people with disabilities from moving traffic.
- 9.13 Bays should be marked with lines and the International Symbol for Access with the safety zone/aisle between the bays marked with hatchings. Disabled parking bays marked on the highway should be in white and in accordance to the Traffic Signs Regulations and General Directions 2016, off the highway spaces should be marked in yellow with disabled logo. Dropped kerbs should be provided where necessary and pedestrian routes to and from these spaces for people with disabilities should be free from steps, bollards and steep slopes wherever possible.
- 9.14 The dwellings intended to be lifetime homes should be shown on submitted plans and be in line with Part M4 (2) of the building regulations.

# Cycle Parking in Residential Developments

## 10 Cycle Parking design and layout

### Cycle parking principles

- 10.1 The Basingstoke and Deane Cycle Strategy (2016) provides an overarching framework for encouraging cycling in the borough and ensuring that cycling is taken into account in planning proposals. One of its objectives is to encourage the provision of secure cycle parking facilities in new development. Ensuring enough convenient and secure cycle parking at people's homes and other locations for both residents and visitors is critical to increasing the use of cycles in order to improve health and well-being and encourage more sustainable modes of travel.
- 10.2 Applicants should clearly demonstrate where and how cycle parking will be provided. All cycle parking must be:
- Secure and covered;
  - Conveniently located adjacent to entrances/exits to buildings;
  - Enjoy good natural observation;
  - Be easily accessible from roads and/or cycle routes and;
  - Be well lit.
- 10.3 In residential situations:
- If a garage is to be considered as a cycle parking space it should be a minimum of 3.3m by 7m internal dimensions.
  - Any storage facility other than a garage provided for the express purpose of cycle storage should be at least 2m in length by 0.9m wide to fit one bicycle, or larger for more than one bicycle. Such a storage facility should be accessible from the outside of a property.
  - External access to a rear garden with a cycle store such as a shed would be treated as provision of cycle storage.

### Cycle parking design

- 10.4 The average adult sized cycle has a length of 1.8m with handlebars having a width of 0.65m. Therefore the typical minimum internal dimensions of 2m by 1m will be required to comfortably accommodate an average adult cycle.
- 10.5 If communal stores are to be provided, generally for flatted developments, they should be fully covered and contain cycle stands in the form of Sheffield stands or similar, to allow individual cycle frames and wheels to be secured horizontally and to ensure that they are individually accessible. These should be lit, secure and in a location that is accessible and convenient for users. Vertically arranged bike racks or similar which require lifting are not suitable for everyone so they must not contribute more than 40% of the overall racking provision. The diagrams below illustrate the approach to design recommended.



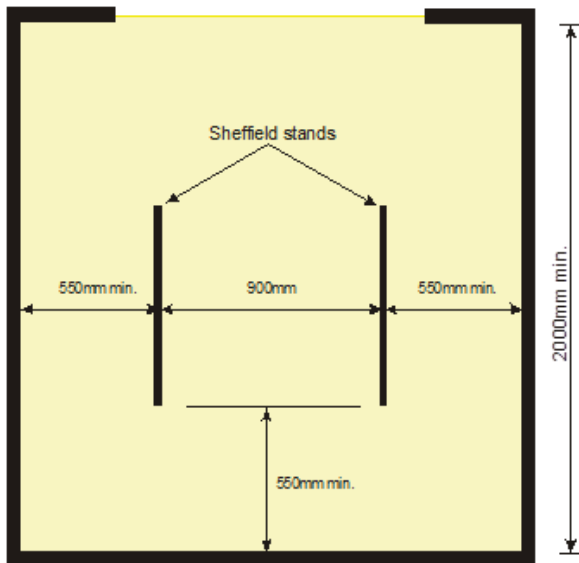

Sheffield Type Stands: Plan of communal store for four cycles using Sheffield stands

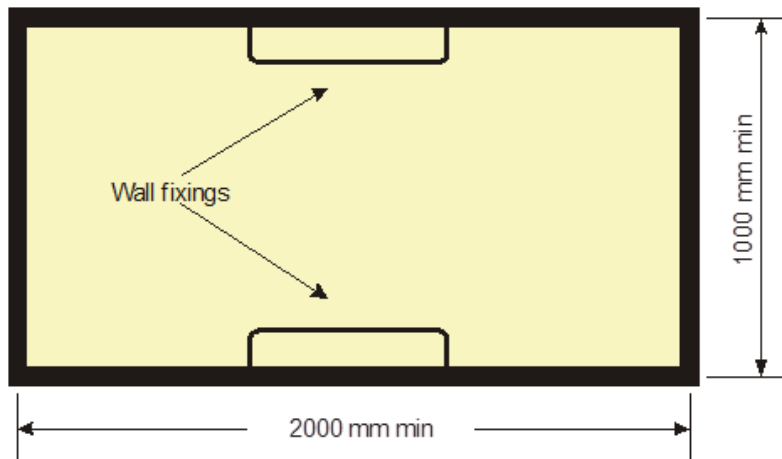

Plan of store for cycles using wall fittings

10.6 Other types of stand such as secure cycle lockers and two-tier racks are also acceptable for certain long stay cycle parking situations. There are a number of different products available, a number of which are shown as examples below.

*Cycle Locker Dimensions*

*Cycle locker example*

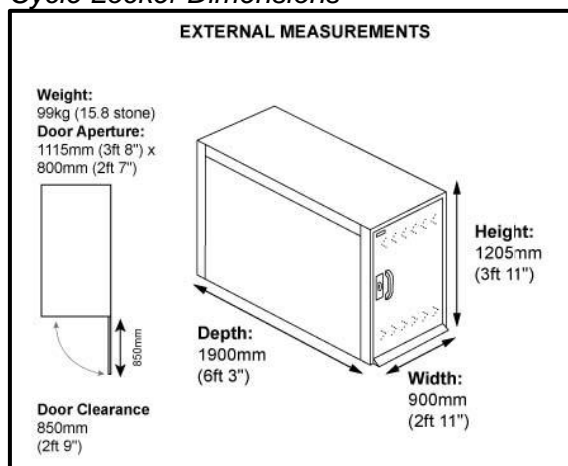

*Covered shelter with lockable gates example*



*Two tier racks in covered shelter example*



- 10.7 Additional guidance and best practice relating to siting and designing cycle parking can be found in a number of documents including Sustrans guidance and the Cambridge Cycle Parking Guide. Links to these document can be found in the reference list.

# PART B: NON RESIDENTIAL PARKING

## Non Residential Parking Standards

### 11. Background Evidence

#### Review of parking standards

- 11.1 The Hampshire County Council non-residential Parking Standards (2002) applied reductions in car parking for levels of accessibility by land use. Although this approach has proved successful in large urban areas with good levels of public transport, the application of notional reductions in parking standards within defined accessibility zones is less applicable to locations that are not served by a comprehensive bus and rail network which can compete with the convenience of private car journeys.
- 11.2 Furthermore in line with the national guidance at the time, the 2002 standards have been applied as either maximum or minimum figures rather than expected levels where exceptions can be permitted where justified. This has led to over or under provision of parking in some locations. The evidence also suggests that it is also important to consider the use-classes order in a finer grain to differentiate between different types of development proposed as, for example different models are now being used by retailers.
- 11.3 Significant parking problems also emanate from the intensification of use associated with existing sites for example the substantial increase in the number of doctors and medical staff working at surgeries without any increase in footprint. It is therefore relevant to give consideration to the whole life cycle of the proposed development.
- 11.4 The 2011 Census suggests there is strong self-containment in Basingstoke and Deane with 66% of those employed either working at destinations within the borough or at home (of those 60% travelled to work by car.)
- 11.5 The census also suggests there are high levels of self-containment in the urban areas of Basingstoke, along with Oakley and Sherborne St John. In Eastrop and Grove for example, 18% of those that are employed work within close proximity to their residence and of those only 26% travel to work using a car.
- 11.6 Whilst the evidence relating to travel to work from the census suggests a high level of self-containment within the borough as a whole, car dependency for travel to work journeys when analysed at a borough level also suggests high dependency on the car for journeys to work particularly outside of the urban area of Basingstoke.

#### Conclusions drawn from the background evidence

- 11.7 Overall the evidence points to journey destinations having the greatest influence upon the mode of transport used. Journeys tend to be influenced by other demand management measures, such as high quality cycling facilities, access to rail and bus services and proactive travel plans. Businesses should, wherever possible, encourage employees to adopt sustainable travel patterns. This can be achieved through the use of smarter choices measures implemented through travel plans. It is however

recognised that a balance is required between providing for business needs and the cost attributed to providing parking and attracting/retaining staff.

- 11.8 In comparative terms Basingstoke benefits from the availability of public off-street parking spaces in public car parks and better access to rail and bus services. It can therefore be expected that this will lead to lower levels of parking demand at individual sites with consequential reduction in appropriate parking standards, particularly for retail related planning applications where public car parks are available. Where spaces are required, consideration should be given to providing parking through the implementation of underground and under-croft solutions.
- 11.9 It is therefore concluded that the non-residential parking standards within Basingstoke's ring road remain lower due to higher accessibility and to encourage more efficient land use. Also, as these non-residential uses are likely to be the destination of a trip (rather than an origin), availability of parking at these destinations and attractiveness of alternative modes of transport is likely to have a stronger influence on the mode used to access these destinations when compared with the rest of the borough.

## **12. Table of Non-Residential Parking Standards**

- 12.1 Proposals should avoid over generous parking provision to use land efficiently. It should therefore not be assumed that a proposal will automatically be acceptable just because it does not exceed the parking standards and applicants for non-residential development should demonstrate what measures they are taking to minimise the need for people to travel to the site by private car to reduce the need for car parking.
- 12.2 Equally, proposals with substantially reduced parking provision may be unacceptable if the Council considers that this would result in parking pressure on existing or proposed streets which cannot be reasonably mitigated.
- 12.3 The applicant is required to demonstrate the approach this has been taken to parking provision and why through parking surveys, travel plans or a parking statement.
- 12.4 In applying the standards overleaf applicants must also take into account the notes set out below the table. These include:
- provision of electric vehicle charging points
  - sustainable drainage
  - 5% of parking spaces provided for disabled parking and powered two wheelers
  - parking space dimensions

**Table 2: Non Residential Parking Standards**

Type/ Use	Car Parking Standard		Cycle Parking Standard	
	Inner urban (within Basingstoke ring road)	Outer urban and rural (remainder of the borough)	Long Stay	Short Stay
<b>RETAIL</b>				
A1 Non-food retail and general retail (covered retail areas)	1 space per 30m <sup>2</sup> covered areas	1 space per 20m <sup>2</sup> covered areas	1 space per 6 staff or 1 per 300m <sup>2</sup> (whichever is greater)	1 space per 200m <sup>2</sup>
A1 Non-food retail and general retail (uncovered retail areas)	1 space per 40m <sup>2</sup> uncovered areas	1 space per 30m <sup>2</sup> uncovered areas	1 space per 6 staff or 1 per 300m <sup>2</sup> (whichever is greater)	1 space per 200m <sup>2</sup>
A1 Food retail	1 space per 18m <sup>2</sup> covered areas	1 space per 14m <sup>2</sup> covered areas	1 space per 6 staff	1 space per 200m <sup>2</sup>
A2 Financial banks and professional services	1 space per 30m <sup>2</sup>	1 space per 20m <sup>2</sup>	1 space per 6 staff or 1 per 300m <sup>2</sup> (whichever is greater)	1 space per 200m <sup>2</sup>
<i>Departures from the cycle parking standards for retail development may be acceptable for larger retail proposals where supported by a travel plan.</i>				
<b>FOOD AND DRINK</b>				
Garden centres	<i>Applications will be considered on a case by case basis following review of transport assessment/travel plan.</i>			
Eating and drinking establishments (including public houses, cafes and restaurants)	1 space per 5m <sup>2</sup>	1 space per 5m <sup>2</sup>	1 space per 5 staff	2 spaces per establishment
Take-away hot food shops	1 space per 3 staff	1 space per 3 staff	1 space per 8 staff	2 spaces per establishment

Type/ Use	Car Parking Standard		Cycle Parking Standard	
	Inner urban (within Basingstoke ring road)	Outer urban and rural	Long Stay	Short Stay
<b>COMMERCIAL</b>				
B1(a) Office	1 space per 45m <sup>2</sup>	1 space per 30m <sup>2</sup>	1 space per 8 staff or 1 stand per 150m <sup>2</sup> (whichever is greater)	1 space per 300m <sup>2</sup>
B1(b)(c) High-tech/ light industry	1 space per 60m <sup>2</sup>	1 space per 45m <sup>2</sup>	1 space per 8 staff or 1 stand per 250m <sup>2</sup> (whichever is greater)	1 space per 500m <sup>2</sup>
B2 General industrial	1 space per 60m <sup>2</sup>	1 space per 45m <sup>2</sup>	1 space per 8 staff or 1 stand per 350m <sup>2</sup> (whichever is greater)	1 space per 500m <sup>2</sup>
B8 Warehouse	1 space per 300m <sup>2</sup>	1 space per 90m <sup>2</sup>	1 space per 10 staff or 1 stand per 500m <sup>2</sup> (whichever is greater)	1 space per 600m <sup>2</sup>
<i>Where B2 and B8 uses have a retail/trade counter applications will be considered on a case by case basis following review of transport assessment/travel plan.</i>				
<b>EDUCATION</b>				
D1 Educational Establishments (schools)	Refer to Hampshire County Council School Parking Guidelines which can be found <a href="#">here</a> . Applicant expected to demonstrate whether parking controls are needed on surrounding roads.			
D1 Education Establishments ( 16+ and further education)				
D1 Educational Establishments (day nursery, playgroup, crèche)	1 per 2 staff	1.5 spaces per 3 staff	1 stand per 6 staff	1 stand per establishment

Type/ Use	Car Parking Standard		Cycle Parking Standard	
	Inner Urban (within Basingstoke ring road)	Outer urban and rural	Long Stay	Short Stay
<b>HEALTH</b>	<i>To be assessed on a case by case basis following review of transport assessment/travel plan</i>			
Private hospitals, community and general hospitals				
D1 Health centres and doctors surgeries	3 spaces per consulting room	5 spaces per consulting room	1 space per 5 staff	1 space per consulting room
D1 Dentists or veterinary surgery	3 spaces per consulting room	3 spaces per consulting room	1 space per 5 staff	1 space per consulting room
<b>CARE</b>				
Day centres for older people, adults with learning/ physical disabilities	1 space per 3 staff plus 1 space per 3 clients	1 space per 2 staff plus 1 space per 2 clients	1 space per 8 staff	2 spaces per establishment plus 1 stand per 200m <sup>2</sup>
Homes for children	1 space per 2 residential staff, 1 space per 4 non-residential staff plus 1 space per 6 clients	1 space per residential staff, 0.5 space per non-residential staff plus 0.25 space per client	1 space per 5 staff	2 spaces per establishment plus 1 stand per 200m <sup>2</sup>
Family centres	1 space per 3 staff plus 1 space per 3 clients	1 space per 2 staff plus 1 space per 2 clients	1 space per 6 staff	2 spaces per establishment plus 1 stand per 200m <sup>2</sup>
Residential units for adults with learning or physical disabilities	1 space per residential 1.5 staff plus 1 space per 4 non-residential staff plus 1 space per 6 client	1 space per residential staff plus 0.5 space per non-residential staff plus 0.25 space per client	1 space per 6 staff	1 space per 2 bedrooms
Hostels	Assessed on a case by case basis		1 space per 4 staff	1 space per 2 bedrooms



Type/ Use	Car Parking Standard		Cycle Parking Standard	
	Inner Urban (within Basingstoke ring road)	Outer urban and rural	Long Stay	Short Stay
<b>ASSEMBLY AND LEISURE</b>				
Hotels/ motels/ guest houses/ boarding houses	1 space per bedroom plus 1 space per 2 staff	1 space per bedroom plus 1 space per 2 staff	1 space per 5 staff or 1 space per 40m <sup>2</sup> (whichever is greater)	1 space per 10 bedrooms
Eating and drinking establishments	1 space per 7.5m <sup>2</sup> of public floorspace	1 space per 5m <sup>2</sup> of public floorspace	1 space per 4 staff or 1 space per 40m <sup>2</sup> (whichever is greater)	1 space per 20m <sup>2</sup>
Cinemas, multi-screen cinemas, theatres and conference facilities	1 space per 7.5 fixed seats	1 space per 5 fixed seats	1 space per 6 staff or 1 space per 40m <sup>2</sup> (whichever is greater)	1 space per 20m <sup>2</sup>
Bowling centres, bowling greens	1.5 spaces per lane	3 spaces per lane	1 space per 6 staff or 1 space per 40m <sup>2</sup> (whichever is greater)	1 space per 20m <sup>2</sup>
Sports halls	1 space per 7.5 fixed seats plus 1 space per 40m <sup>2</sup> of public space	1 space per 5 fixed seats plus 1 space per 30m <sup>2</sup> of public space	1 space per 6 staff	1 space per 10m <sup>2</sup>
Swimming pools, health clubs, gymnasias	1 space per 7.5 fixed seats plus 1 space per 15m <sup>2</sup> of open hall/ pool area	1 space per 5 fixed seats plus 1 space per 20m <sup>2</sup> of open hall/ pool area	1 space per 6 staff or 1 space per 40m <sup>2</sup> (whichever is greater)	1 space per 10m <sup>2</sup>
Tennis courts	1.5 spaces per court	3 spaces per court	1 space per 6 staff	1 space per court
Squash courts	1 space per court	2 spaces per court	1 space per 6 staff	1 space per court
Playing fields	Determined with travel plan	12 spaces per ha pitch area	1 space per 6 staff of a pace per 5ha pitch area	1 space per ha pitch area
<i>Where Artificial Grass Pitches are proposed which are likely to have a higher intensity of use applications will be considered on a case by case basis following review of transport assessment/travel plan.</i>				
Golf courses	Determined with travel plan	4 spaces per hole	1 space per 8 staff	5 spaces per 9 holes

Type/ Use	Car Parking Standard	Cycle Parking Standard	Long Stay	Short Stay
	<b>Inner Urban (within Basingstoke ring road)</b>	<b>Outer urban and rural</b>		
Golf driving ranges	Determined with travel plan	1.5 spaces per tee/ bay	1 space per 8 staff	1 space per 5 tees/ bays
Marinas	Determined with travel plan	1.5 space per berth	Assessed on a case by case basis	1 space per 4 berths
Places of worship/ church halls	1 space per 5 fixed seats plus 1 space per 10m <sup>2</sup> of open hall	1 space per 8 fixed seats plus 1 space per 10m <sup>2</sup> of open hall	1 space per 6 staff	1 space per 20m <sup>2</sup>
Community building/village hall	1 space per 10m <sup>2</sup> of open hall	1 space per 10m <sup>2</sup> of open hall	1 space per 6 staff	1 space per 20m <sup>2</sup>
Stadia	Assessed on a case by case basis			
Workshops- staff	1 space per 3 staff	1 space per 2 staff	1 space per 6 staff	No minimum
Workshops- customers	3 spaces per service bay	3 spaces per service bay	No minimum	2 spaces
Car sales- staff	1 space per 2 staff	1 space per 2 staff	1 space per 6 staff	No Minimum
Car sales- customers	1 space per 10 showroom spaces	1 space per 10 showroom spaces	No minimum	2 spaces

**In applying the above standards, the following considerations must be taken into account:**

1. Figures provided in the table should be viewed as the expected standard, however, each development will be considered on an individual basis taking into account local circumstances and evidence. In highly accessible areas parking provision to a lower standard may be appropriate if circumstances permit and incentives, such as car clubs, are provided as part of a development. Developers will be expected to provide evidence to demonstrate the approach taken.
2. All proportions to be rounded up to the next whole number.
3. Mixed use developments should sum the requirements of the different uses whilst taking into account the opportunities for the shared use of space at different times of the day/week.
4. Unless otherwise stated, floor areas are gross external areas (GEA), including the thickness of the external wall.
5. "staff" applies to full-time equivalent member of staff

6. “Private hospitals, community and general hospitals” to include: inpatient, day patient, outpatient or accident unit; locally based mentally handicapped units/ psychiatric units; ambulatory care units including day surgery/ assessment/ treatment and administration/ support services.
7. A minimum of 5% of spaces should be designated for use by disabled people, or available for future conversion, with a minimum of 1 space per individual development. These parking spaces should be clearly marked with the international symbol for access and located close to the entrance
8. Where appropriate, such as at care establishments, the need to provide parking and charging facilities for disability motor scooters should be considered.
9. Parking spaces for powered two wheelers should be provided for all sites at a minimum level of 5% of total car parking spaces or one for every 25 parking spaces (whichever is greater)
10. It is expected that operational parking is provided in line with the requirements in section 13 informed by a transport statement, transport assessment or travel plan. Potential issues at peak times should be considered such as drop-off and pick up at schools and nurseries.
11. All parking should be part of a Sustainable Urban Drainage System (SuDS) unless there are technical reasons why this cannot be done. Permeable surface materials should be used wherever possible to reduce surface water runoff.
12. For some developments, shared use of parking areas for users of more than one development/destination may be possible. For example, many evening leisure destinations rely on public parking that is used by retail and employment development visitors and employees during the day, without conflict. Such shared use will be encouraged in instances where developers can demonstrate that shared use will not result in conflict or demand beyond parking supply. In instances where the viability of shared use can be demonstrated, the council will permit development with appropriate reductions in dedicated parking provision.
13. Electric vehicle charging infrastructure should be provided off highway as set out in section 15. Where these requirements aren't met car parking spaces should be laid out to ensure charging points can be easily retrofitting in line with guidance in section 9.
14. Minimum parking space dimensions are set out in section 13.
15. All parking provision should be in line with recommendations in the Design and Sustainability SPD.

# Design and Layout of Parking in Non-Residential Developments

## 13. Parking Space Requirements

- 13.1 Parking design and layout of non-residential developments needs to include spaces for staff, visitors and customers as well as operational and servicing needs. The non-operational requirements can be sub-divided into: regular parking spaces, disabled parking spaces, cycle parking, powered two wheelers and electric vehicles (including charging). Operational needs include pick up, drop off and deliveries.
- 13.2 Parking should be designed to ensure the needs of the all elements of the community have been taken into account, facilities should be convenient, user-friendly and well lit, designed to limit the opportunity for crime and to promote natural surveillance, be managed and maintained and allow access and movement.

### Parking space dimensions

- 13.3 The required parking space size for cars is 2.7m wide by 5.2m in length. Where smaller spaces are proposed, robust supporting information must be submitted to justify the approach taken. Space sizes smaller than 2.5m wide by 5.0m in length will not be accepted. Table B below sets out the requirements associated with different parking space configurations.

*Table B: Parking space dimensions for non-residential developments*

Type of Car Parking Space	Parking space requirements
Parking space size: 2.7m wide by 5.2m in length	
Parallel Parking Bays	Should be designed so that bays cannot be used for echelon parking. A suitable adjacent hardstanding margin (minimum width 1.2m) is also required where an adjacent 2m footway is not present
Perpendicular Bays (90° to approach)	6m required between aisles for manoeuvring.
Echelon Bays (60° to approach)	Bays should be arranged to encourage reverse parking. 4.2m required between aisles for manoeuvring.
Echelon Bays (between 30° and 45° to approach)	Bays should be arranged to encourage reverse parking. 3.6m required between aisles for manoeuvring.
Disabled Bays	Should be located no more than 50m to main entrance with flush kerbs installed as required. An additional 1m both sides and the rear of the space is required for access.
Electric Vehicle Charging Point spaces	Additional 1m access stip.

## Disabled Parking

- 13.3 Non-residential developments should provide a minimum of 5% of their total parking allocation as disabled spaces. Disabled parking bays marked on the highway should be in white and in accordance to the Traffic Signs Regulations and General Directions 2016, off the highway marked in yellow with disabled logo. Disabled spaces should usually be located as close to the entrance to the destination point as possible, and dropped kerbs should be provided to enable easy access from disabled parking bays to/from the footway.
- 13.4 Developments for elderly persons and other developments which are likely to be used by people with disabilities may require a higher provision of disabled spaces and should make adequate provision for access, parking and charging of mobility vehicles.

## 14. Operational Parking and Servicing/Loading Facilities

- 14.1 Operational needs include parking for deliveries, maintenance and loading. These requirements will vary depending on land use, for example a retail outlet will require parking space for regular deliveries and a place of public assembly may require space for coach or mini-bus parking. Therefore, developments should be located and designed where practical to (amongst other things) accommodate the efficient delivery of goods and supplies and so they can accommodate the largest vehicle anticipated to attend the site.
- 14.2 Due consideration must be given to operational requirements of each site so as to avoid the need for service and delivery vehicles to park in unsuitable locations. The required amount and location of operational parking space will be considered on a site by site basis, in general terms servicing area could include the following:
- The number of bays required for deliveries to all business units, designed to accommodate the size of service vehicle
  - Storage and welfare facilities for service area personnel
  - Refuse collection
  - Collect-by-car spaces in retail developments where relevant
- 14.3 Some general requirements for the provision of operation and servicing parking are set out below:

*Table C: Operational parking space requirements for non-residential development*

Type of use	Parking requirements
Industrial / warehouse (B1c/B2/B8) uses	For the first 2000sqm, one lorry space per 500sqm For floorspace over 2000sqm, one lorry space per 1000sqm
Retail and other uses	Applicant to demonstrate that lorry/van deliveries can be made without disruption or reduced safety to customers or other users of the highway
Drop-off spaces for nurseries, day centres and health establishments	Number of drop-off spaces determined on the basis of the scale and specific proposed use such as location and accessibility.
Car sharing and pool cars	Car sharing and pool car spaces should be well located, convenient and adjacent to charging points

Taxi pick up and drop off	Provision for taxis to pick up and drop off passengers where appropriate
Hotels	Provision of overnight parking for coaches/minibuses where appropriate
Sports pitches/sports clubs/leisure uses	Provision of mini-bus and coach parking and turning demonstrated by travel plan/assessment relating to intended use and catchment
Overnight parking	The requirement for overnight parking will need to be considered where a fleet of vehicles are operated from the premises. It is assumed that the management plan will detail any overnight parking provision.
Parking bay sizes	7.5m x 3.5m for vans and minibuses 12.0m x 3.5m for rigid trucks, buses and coaches 17.0m x 3.5m for articulated trucks and 35m to 45m for articulated truck to manoeuvre into a space at right angles to the road.

- 14.4 The design of access roads and on-site layby/turning facilities should be determined and/or validated using tracking simulation software. Sufficient space should also be allowed for servicing vehicles to enter and leave the curtilage of the premises in a forward gear.

## 15. Electric vehicle charging

- 15.1 As noted in the residential section of this SPD the Council supports the provision of electric vehicle charging points as part of new development. The provision of electric vehicle charging and parking is particularly relevant where uses attract a large number of visitors and given the expectation that pool cars will be electric or hybrid vehicles. Applicants are also encouraged to make provision for electric vehicle charging infrastructure in village halls and community centres. There is an expectation that electric vehicle charge points should be provided for proposals for 30 spaces or more or at a ratio of 1 charge points per 30 spaces (1:30) unless it can be demonstrated it isn't viable.
- 15.2 The location of charge points should be convenient for users with consideration to the scope to charge more than one vehicle. The following technical standards should be applied:
- Bays should meet minimum space dimensions
  - Charge points must be protected from collision and should be positioned to avoid becoming an obstruction or trip hazard
  - Charge points and cable enabled points must be shown on the layout plan
  - Bays should be signed and marked for electric vehicle charging only.
  - Where possible charging infrastructure should be installed at the same as other infrastructure required to serve the development
  - Designed to minimise visual impact
- 15.3 Where electric vehicle charging points are not provided, parking areas should be designed so that charging infrastructure can be retrofitted at a later date with minimal disruption. Suggested ways to ensure that retrofitting is possible are set out in the residential parking section of this document in section 9.
- 15.4 A high number of vehicles travelling into Basingstoke town centre at peak times contain only one occupant. With increased levels of car sharing there is a potential reduction on

the need for parking spaces as well as a reduction in congestion on the highway network. It is expected that car club vehicles will be electric vehicles.

- 15.5 Details of electric vehicle charge points must accompany full and reserved matters planning applications. Outline applications need only a commitment to provide details at the reserved matters stage.

## 16. Motorcycle, Moped and Scooter Parking

### Powered two wheelers parking design and layout

- 16.1 Motorcycles, mopeds and scooters are seen by many as a convenient and affordable alternative to running a car. The number of motorcycles registered annually in the UK has risen from around 953,000 in 2000 to just over 1.2 million in 2014; meaning that they now account for 3.4% of all vehicles on the UK's roads.
- 16.2 Indiscriminate parking of powered two wheelers (PTWs) can cause a hazard to pedestrians if pavements are blocked or if cycle parking is misused to secure PTWs. In order to reduce the likelihood of indiscriminate parking of PTWs, developments should be designed to include PTW parking which is in a convenient location, with good natural observation, as close as is practical to the trip destination.
- 16.3 Facilities for securing PTWs should be provided through either a ground anchor or a raised anchor point; both of which should be located so that they do not cause a hazard to pedestrians or conflict with other vehicles. Raised anchor points are preferable as they are more visible so less likely to be a trip hazard. These consist of horizontal bars, provided at a height of approximately 400-600mm above ground. An example is shown below.
- 16.4 As with parking for bicycles, parking for PTWs should also offer security, ease of access, and where possible, protection from the elements. For long stay PTW parking (likely to be required at places of employment), facilities for the secure storage of motorcycle helmets and clothing should also be provided, as well as changing facilities.

#### *Examples of motorcycle parking stands*





## 17. Cycle Parking

### Approach to cycle parking

- 17.1 The Basingstoke and Deane Cycle Strategy (2016) provides an overarching framework for encouraging cycling in the borough and ensuring that cycling is taken into account in planning proposals. One of its objectives is to encourage the provision of secure cycle parking facilities in new developments together with end of trip facilities such as changing rooms and showers at workplaces.
- 17.2 Applications for non-residential development should provide a mix of long stay and short stay cycle parking depending upon the likely mix of users. Cycle parking should be located in areas with good natural surveillance and should not be provided in locations where it is necessary to carry the bicycle through a building.

### Short stay cycle parking

- 17.3 Short stay cycle parking is required by visitors or customers to a building and should be located in a safe, convenient location. The provision of Sheffield type stands for short stay cycle parking is recommended as they allow the cycle frame and at least one of the wheels to be locked to the stand. Sheffield type stands provide more stability and security than can be achieved by using a style of stand which only allows the front wheel to be locked and is ideally weather proof. Short stay cycle parking should:
- Allow natural surveillance
  - Be well lit
  - Be conveniently located within a short distance of the building entrance and, where possible, offer a real advantage over the nearest parking space
  - Be located away from bin stores and smoking shelter (or other features that may deter use)
  - When located in the footway, stands should include a tapping rail to warn the visually impaired

*Examples of well-located short stay cycle stands: Sheffield stands complete with tapping rail for extra stability and security*



## Long stay cycle parking

17.4 Long stay cycle parking provides for the needs of the regular users of the building such as staff. As with short stay cycle parking, Sheffield stands are recommended for long stay cycle parking, however in the case of long term cycle parking the Sheffield stands should be secured with a covered, lockable shelter or compound or within a building. For sites where space is limited cycle stand designs other than the Sheffield stand may be acceptable, such as cycle lockers or two-tier cycle stands. The suitability of such cycle parking provision will be assessed on a site by site basis. Long stay cycle parking should:

- Allow natural surveillance
- Be well lit
- Be conveniently located within a short distance of the building entrance and, where possible, offer a real advantage over the nearest parking space
- Be located away from bin stores and smoking shelter or other features that may deter use
- Be clearly signed
- Provide a covered, lockable shelter
- Individual cycle locks for secure storage may be required in some circumstances

17.5 Where long stay cycle parking is provided consideration should also be given to the additional needs of cyclists such as the availability of an appropriate number of showers, changing facilities and lockers as well as space for drying wet clothes.

## Cycle Parking Layout and Design

17.6 The following diagrams indicate the necessary dimensions for Sheffield stands and the amount of space required around each stand to enable safe and efficient use. This dimension and layout guidance should be applied for both short term and long term cycle parking.

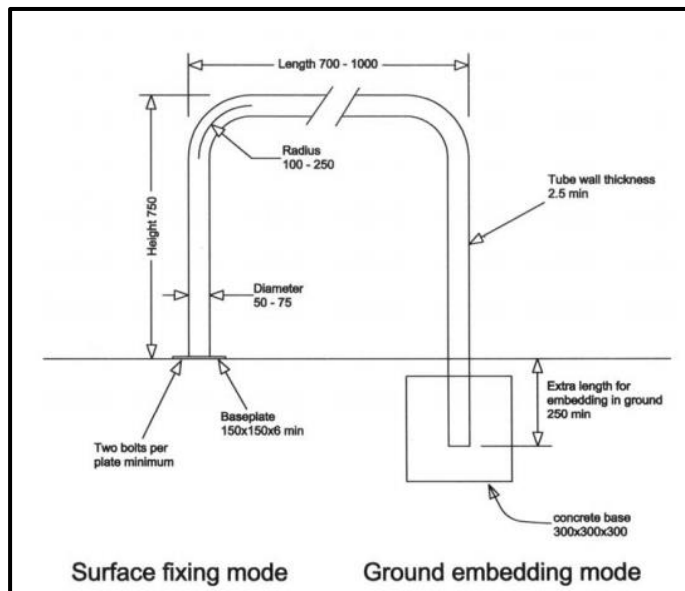

### *Basic Sheffield Stand Dimensions*

*Note: It is preferred that stands are installed using the ground embedding mode rather than the surface fixing mode.*

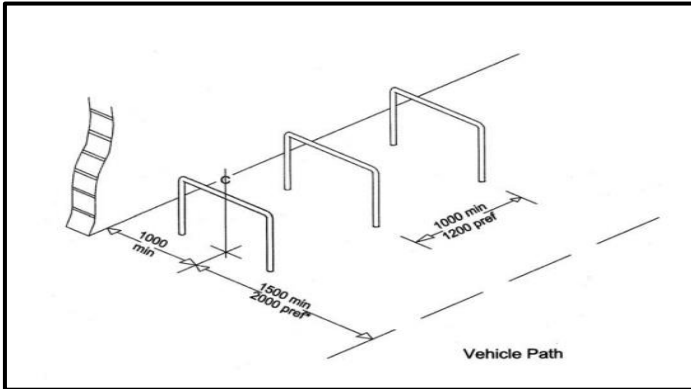

Sheffield stands at 90° to wall of building line and passing vehicles. Note: The preferred distance is 2,000mm from passing vehicles. This may be reduced to 1,500mm where a kerb separates the cycle parking from traffic

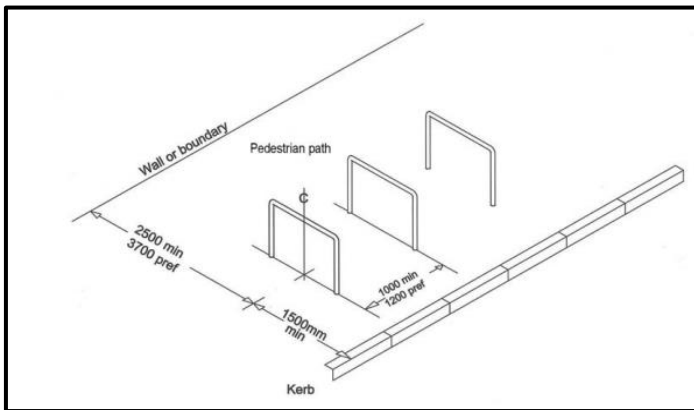

Sheffield stands at 90° to pedestrian path and passing vehicles. Note: The preferred distance is 2,000mm from passing vehicles. This may be reduced to 1,500mm where a kerb separates the cycle parking from traffic.

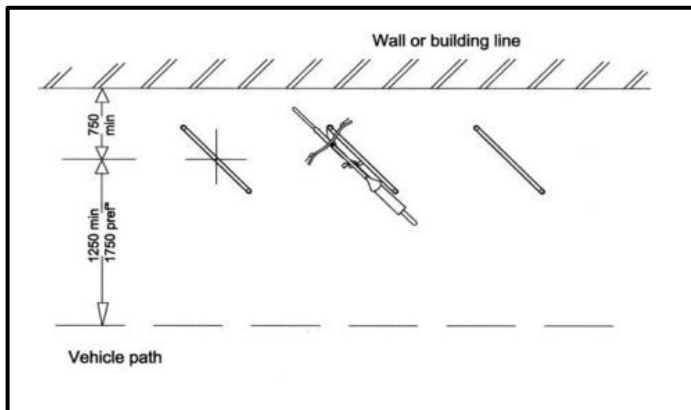

Sheffield stands at 45° to wall and passing vehicles. Note: The preferred distance is 1,750mm from passing vehicles. This may be reduced to 1,500mm where a kerb separates the cycle parking from traffic

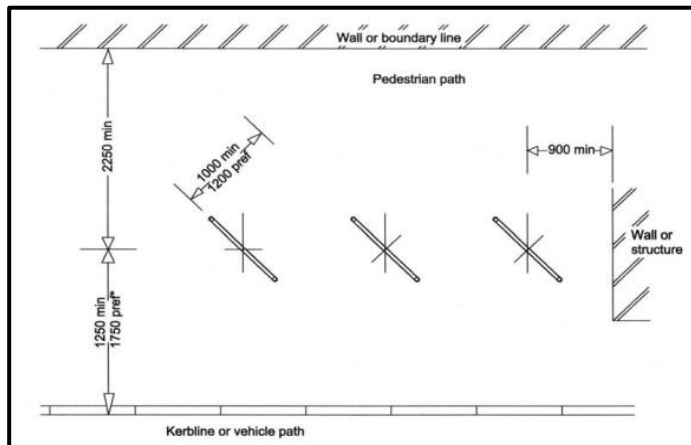

Sheffield stands at 45° to a kerb and pedestrian path

## References

CABE, *What it's like to Live There*, 2005

Carplus, *Annual Survey of Car Clubs in England and Wales*, 2016

Chartered Institute of Highways and Transportation, *Manual for Streets 2*, 2010

Cambridge Cycling Campaign *Cambridge Cycle Parking Guide 2008*  
<https://www.camcycle.org.uk/resources/cycleparking/guide/cycleparkingguide.pdf>

Department for Transport, *Investigation into the Scope for the Transport Sector to Switch to Electric Vehicles and Plugin Hybrid Vehicles*, 2008

Department for Transport, *Manual for Streets*, 2007

Department for Transport, *Road Traffic Forecasts*, 2015

English Partnership and Design for Homes, *Car Parking: What Works Where*, 2006

Freight Transport Association, *Designing for deliveries*, 2006

National Planning Policy Framework, 2012

Office for National Statistics, *Census*, 2011

Hampshire County Council, *On-site school Parking Guidelines April 2013*

Planning Practice Guidance, 2014

Sustrans *Best practice for cycle parking*  
<https://www.sustrans.org.uk/our-services/what-we-do/route-design-and-construction/route-design-resources/best-practice-cycle>

University of Edinburgh, *Space to Park*, 2013

Written Statements to Parliament, *Planning Update 2016*

[www.basingstoke.gov.uk/localplan](http://www.basingstoke.gov.uk/localplan)

01256 844844 | [local.plan@basingstoke.gov.uk](mailto:local.plan@basingstoke.gov.uk)

  @BasingstokeGov



### Sign up

for email updates on council services, news and events.

[www.basingstoke.gov.uk/signup](http://www.basingstoke.gov.uk/signup)

**If you need this information in a different format, for example large print, CD or braille, please contact the council.**

©Basingstoke and Deane Borough Council July 2018

